

100 Series

Flow Switches



TECHNICAL REFERENCE MANUAL

CONTENTS

- 1 Overview**
 - Introduction 1
 - Important Safety Information 1
 - Technical Support 1
 - Warranty 1

- 2 Features and Functions**
 - Capabilities Overview 2
 - How It Works 2
 - Selecting the Right Flow Switch for Your Application 3

- 3 Specifications and Performance**
 - Materials, Flow Ranges, and Connections 4
 - Other Wetted Materials 4
 - Temperature and Pressure Limits 5
 - Operating Characteristics 5

- 4 Installation and Setup**
 - Sensor Orientation 6
 - Pipe or Tube Mounting 6
 - Panel Mounting 6
 - Selectable Flow Range Models 7
 - Minimum Pipe/Connection Inside Diameter 8
 - Proximity to Other Devices 8
 - Filtering 9
 - Plumbing Connections 9
 - Electrical Connections 10
 - Trip Point Adjustment 11

- 5 Maintenance**
 - Recommended Maintenance 13
 - Rebuild Kits 13
 - Required Tools 13
 - Flow Sensor Maintenance Instructions 13



1 OVERVIEW

Introduction

This document provides comprehensive technical information about Proteus 100 Series flow switches. The product features, specifications, and operating instructions described herein apply to standard 100 Series products and may not be valid for all customized versions. For model-specific product information, please contact Technical Support.

Important Safety Information

Throughout these instructions, **NOTE**, **CAUTION**, and **WARNING** statements are used to highlight important operational and safety information.

NOTE 	NOTE statements provide additional information that is important to the successful operation of the device.
CAUTION! 	CAUTION statements identify conditions or practices that could result in damage to equipment or other property.
WARNING! 	WARNING statements identify conditions or practices that could result in personal injury or loss of life.

Taking proper precautions to avoid damage to your device during installation helps to ensure consistent, error-free operation, which lowers costs and assists on-time completion of your work.

The safety-related statements contained in these instructions provide an alert to installers and operators to take sensible steps to allow your 100 Series flow switch to operate correctly the first time and every time.

NOTE	
	It is recommended that the installation of this product be performed by qualified service personnel only.

Technical Support

For technical or applications assistance, please contact:

Proteus Industries Inc.
340 Pioneer Way
Mountain View, CA 94041
TEL: (650) 964-4163
FAX: (650) 965-0304
E-mail: tech@proteusind.com

Warranty

Proteus 100 Series products are manufactured under ISO-9001 certified processes and are warranted to be free from defects in materials and workmanship for five (5) years from the date of shipment. The full text of this limited warranty is available on the Proteus Industries website at www.proteusind.com/warranty.

2 FEATURES AND FUNCTIONS

Capabilities Overview

» Accurate and reliable flow monitoring

100 Series flow switches monitor cooling fluids or other liquid flows and trip an internal relay if the flow rate falls below an adjustable trip point. The relay can be used to sound an alarm or shut down a system or process before damage is done to valuable equipment and products.

- › Flow ranges from 0.2 to 227 LPM / 0.06 to 60 GPM
- › Liquid temperatures to 100 °C / 212 °F
- › Pressure to 1724 kPa / 250 psi with metal faceplate

» Fail-safe system protection

Unlike pressure-activated sensors, the Proteus flow switch provides a true interlock—it will not be fooled by downstream blockages that maintain pressure while stopping flow. The active design combats the problem of particle buildup, which can jam many other types of flow switches: because the rotor is constantly spinning, it clears itself of most buildup. In the unlikely event that a large object in the line interferes with the rotor, the rotor stops turning and the switch goes to its alarm condition.

When a Proteus flow switch indicates that liquid is flowing, there is **always** flow through the switch.

» Easy trip point adjustment

A 20-turn potentiometer provides fine adjustment of the trip point. The potentiometer is positioned in a recess in the electronics cover so that it cannot be adjusted by accident. Turning counterclockwise increases the trip point, and turning clockwise decreases the trip point.

» Flow visibility

A clear polysulfone faceplate allows the rotor to be fully visible, telling you at a glance if your liquid is flowing. Optional metal faceplates enable brass and stainless steel versions to be operated at pressures up to 1724 kPa / 250 psi.

How It Works

As liquid flows through the flow sensor cavity, it causes a rotor to spin. Magnets embedded in the rotor induce voltage in a coil. The amplitude of the induced voltage is at a maximum when a magnet is immediately adjacent to the coil. The amplitude of the induced voltage is proportional to the rotational velocity of the rotor and the linear velocity of the liquid as it passes through the sensor body.

A simple electronic circuit compares the measured voltage to a user-selected trip voltage:

- » When the measured voltage is greater than the voltage achieved at the user-selected trip point flow rate, the relay is held in its active position (energized state).
- » If the measured voltage falls below the voltage achieved at the selected trip point, or if the liquid stops flowing, power to the relay is switched off, and the relay returns to its normal position (de-energized state).

The change of state of the relay contacts is interpreted by the user's equipment to control other system functions, such as to trigger your interlock or alarm system.

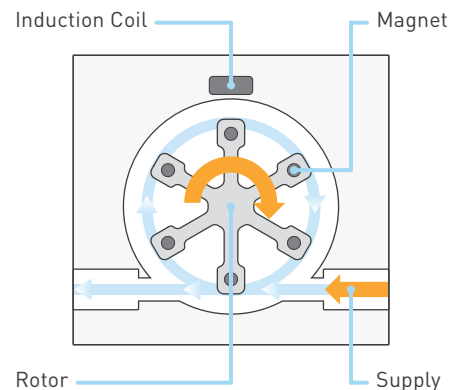

2 FEATURES AND FUNCTIONS

Selecting the Right Flow Switch for Your Application

1. Review the operating temperature and pressure limits to identify suitable materials for the flow sensor.
2. Select a flow body material with the best chemical compatibility with your liquid.
3. Select a flow range so that:
 - a. your nominal flow rate is around 50–60% of the upper flow limit of the sensor;
 - b. your maximum flow rate is lower than the upper flow limit; and
 - c. your trip point flow rate is higher than the lower flow limit.
4. Select your power supply input voltage: 24 VDC or 120 VAC.

For assistance in selecting the flow switch that is best suited to your flow measurement or control process, contact Proteus Applications Support at tech@proteusind.com or (650) 964-4163.

3 SPECIFICATIONS AND PERFORMANCE

Materials, Flow Ranges, and Connections

The table below lists the available materials, flow ranges, and connections for standard 100 Series products. For a complete list of standard model numbers, refer to the 100 Series price list available at www.proteusind.com/100.

MODEL NUMBER ¹				FLOW RANGE ²		CONNECTIONS
CELCON	POLYPROPYLENE	BRASS	STAINLESS STEEL	LPM	GPM	
0100Cxxx	0100Pxxx	0100Bxxx	0100SSxxx	Selectable ³		1/4" FNPT
0104Lxxx	0104Pxxx	0104Bxxx	0104SSxxx	0.2 – 2.3	0.06 – 0.6	1/4" FNPT
0101Cxxx	0101Pxxx	0101Bxxx	0101SSxxx	0.4 – 3.8	0.1 – 1.0	1/4" FNPT
0105Cxxx	0105Pxxx	0105Bxxx	0105SSxxx	1.9 – 9.5	0.5 – 2.5	1/4" FNPT
0103Cxxx		0103Bxxx	0103SSxxx	3.0 – 23	0.8 – 6.0	1/4" FNPT
	0103Pxxx			3.0 – 23	0.8 – 6.0	3/8" FNPT
0150Cxxx	0150Pxxx	0150Bxxx	0150SSxxx	5.7 – 45	1.5 – 12	1/2" FNPT
0155Cxxx	0155Pxxx	0155Bxxx	0155SSxxx	15 – 76	4.0 – 20	1/2" FNPT
	0160Pxxx	0160Bxxx	0160SSxxx	23 – 114	6.0 – 30	3/4" FNPT
	0170Pxxx	0170Bxxx	0170SSxxx	38 – 227	10 – 60	1" FNPT

¹The "xxx" in the model numbers is a placeholder for the power supply input voltage indication: "24" = 24 VDC; "110" = 120 VAC.

²Listed flow ranges are for water at 25 °C / 77 °F.

³0100xxxx models can be configured for any of the three flow ranges available in the 0101xxxx, 0105xxxx, or 0103xxxx models. For more information, please refer to **Selectable Flow Range Models** on page 7.

CAUTION!



DO NOT exceed the maximum rated flow rate of your 100 Series flow switch.
Extended operation above the rated maximum flow rate of the device will reduce its usable life.

Other Wetted Materials

COMPONENT	AVAILABLE MATERIALS	
	STANDARD	OPTIONAL
Faceplate*	Clear Polysulfone	Brass • Stainless Steel
Rotor	PPS	N/A
Rotor Shaft	316 Stainless Steel	Alumina
O-Ring	Buna-N	Viton® • EPDM • Silicone Rubber

*Metal faceplates should only be installed on models with a metal flow body.

3 SPECIFICATIONS AND PERFORMANCE

Temperature and Pressure Limits

FLOW BODY MATERIAL	FACEPLATE MATERIAL	TEMPERATURE LIMIT*		OPERATING PRESSURE LIMIT		BURST PRESSURE (5:1)	
		°C	°F	kPa	psi	kPa	psi
Celcon®	Clear Polysulfone	75	167	517	75	2586	375
Polypropylene	Clear Polysulfone	70	158	517	75	2586	375
Brass	Clear Polysulfone	100	212	689	100	3447	500
	Brass	100	212	1724	250	8618	1250
Stainless Steel	Clear Polysulfone	100	212	689	100	3447	500
	Stainless Steel	100	212	1724	250	8618	1250

*This is the fluid temperature that can be sustained with the flow meter cooled by ambient air up to 20 °C / 68 °F. The temperature of the electronics should not exceed 50 °C / 122 °F. For liquid temperatures above 85 °C / 185 °F, the electronics should be mounted remotely from the flow sensor. For more information, please contact Proteus Applications Support.

WARNING!



DO NOT exceed the temperature limit of the flow sensor body or faceplate material. Operation above the rated temperature can cause failure and create a hazard to operators and equipment.

WARNING!



DO NOT exceed the pressure limit of the flow sensor body or faceplate material. Operation above the rated pressure can cause failure and create a hazard to operators and equipment.

Operating Characteristics

Ambient Temperature	0 to 100 °C / 32 to 212 °F (non-condensing)
Kinematic Viscosity	Up to 120 cSt at operating temperature
Hysteresis	Typically 15% of selected trip point flow rate
Pressure Drop	Typically less than 41 kPa / 6 psi at maximum flow rate
Switch Type	Relay closure, normally open (N.O.) and normally closed (N.C.) contacts provided
Relay Rating	SPDT, 3 A at 30 VDC for a non-inductive load. Mechanical rating > 10 ⁶ cycles.
Power Requirements	24 VDC version: 24 VDC ± 10%, 30 mA 120 VAC version: 120 VAC ± 10%, 30 mA, 50–60 Hz
Electrical Connections	24 VDC version: 5-core conductor for relay and power 120 VAC version: 3-core conductor for relay; 2-pin plug for power
Cable Length	24 VDC version: 0.9 m / 3 ft (relay and power) 120 VAC version: 0.9 m / 3 ft (relay); 1.8 m / 6 ft (power)
Weight	0.9 to 2.7 kg / 2 to 6 lb, depending on model and materials

4 INSTALLATION AND SETUP

Sensor Orientation

For best results, 100 Series flow switches should be mounted in a horizontal pipeline with the faceplate in the vertical plane. Mounting the device with the flow connections uppermost can help eliminate entrained air from your system.

CAUTION!



If the flow switch is mounted in a vertical pipeline, any leakage from the topmost connection could enter the unit and cause permanent damage to the electronics.

Pipe or Tube Mounting

If rigid piping or tubing is used, the flow switch may be supported by direct connection to the pipe or tubing.

Panel Mounting

To mount the flow switch behind a panel, a minimum of two (2) of the standard faceplate-securing screws will need to be replaced with longer screws to compensate for the thickness of the panel.

CAUTION!



Ensure that the screws are not so long as to touch the end of the tapped hole in the flow body or, for polypropylene or Celcon units, to tear through the back of the plastic body if over-tightened.

CAUTION!



Use washers with a larger diameter than the countersinks in the faceplate in order to spread the load. Otherwise, cracks can develop in the faceplate because of extra stress on the countersinks.

1. Prepare the mounting panel by evenly spacing up to six (6) holes on a 63.50 mm / 2.50 in. bolt circle for the #8-32 securing screws. Using the two (2) holes on the horizontal plane is usually sufficient to support smaller models with metal bodies and all models with plastic bodies.
2. If you wish for the rotor to be visible, cut a 43.18 mm / 1.70 in. diameter hole with the same center as the bolt circle.
3. Remove two (2) or more of the screws securing the faceplate to the flow sensor body.
4. Place the unit behind the panel and insert the longer screws through the panel and into the flow sensor body.
5. Secure the screws in the sensor body with a torque of approximately 1.2 N·m / 10 in-lb (finger tight with a flat-head screwdriver).

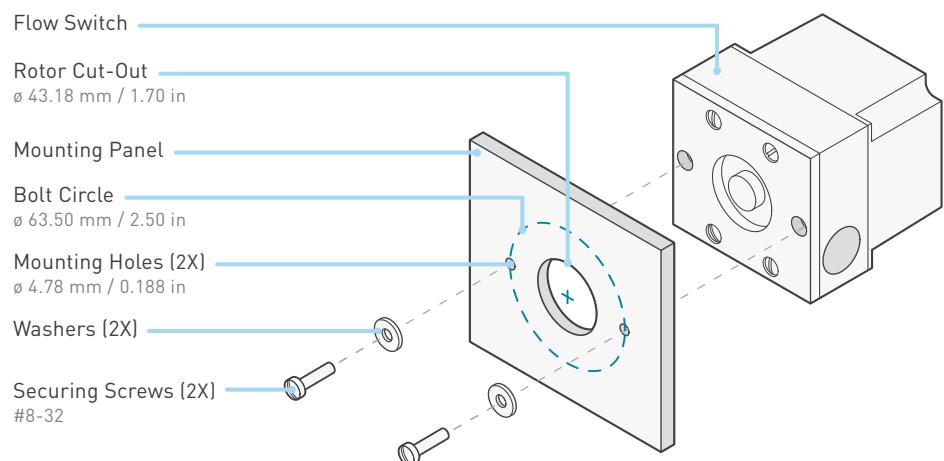

4 INSTALLATION AND SETUP

Selectable Flow Range Models

100 Series products featuring a selectable flow range (0100xxxx models) can be configured for one of three possible flow ranges:

- » 0.4 – 3.8 LPM / 0.1 – 1.0 GPM (similar to 0101xxxx models)
- » 1.9 – 9.5 LPM / 0.5 – 2.5 GPM (similar to 0105xxxx models)
- » 3.0 – 23 LPM / 0.8 – 6.0 GPM (similar to 0103xxxx models)

The flow bodies of these products contain four ports, two of which must be plugged using provided blanking plugs. The placement of the blanking plugs determines the usable flow range.

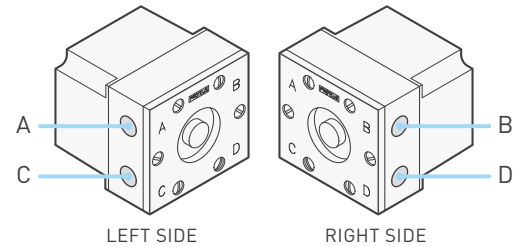

Configuration	101 (similar to 0101xxxx)	105 (similar to 0105xxxx)	103 (similar to 0103xxxx)
Flow Range	0.4 – 3.8 LPM / 0.1 – 1.0 GPM	1.9 – 9.5 LPM / 0.5 – 2.5 GPM	3.0 – 23 LPM / 0.8 – 6.0 GPM
Inlet	A	B*	D
Outlet	B	C	C
Plugs	D, C	A, D	A, B

*This configuration requires the connections to the induction coil to be reversed. Details and instructions are provided below.

NOTE



To configure a 0100xxxx model for a flow range of 1.9–9.5 LPM / 0.5–2.5 GPM, it is necessary to reverse the connections to the induction coil for proper operation of the flow switch.

CAUTION!



The electronics in a 100 Series flow switch are sensitive to electrostatic discharge (ESD). Proper ESD precautions should be taken when handling the device's electronic components.

» Reversing Induction Coil Connections

1. Disconnect all electrical and plumbing connections to the flow switch.
2. Place the flow switch on a clean, flat surface.
3. Remove and retain the four (4) screws securing the electronics enclosure to the flow sensor body.
4. Carefully separate the electronics enclosure from the body to reveal the white and black wires that are connected to the induction coil circuit board by two spade connectors. The default wire positions are marked **W** (white) and **B** (black) on the body and also on the circuit board beside the corresponding spade terminals.
5. Gently disconnect both spade connectors from the induction coil circuit board.
6. Reconnect the **white** wire to the spade terminal marked **B**.
7. Reconnect the **black** wire to the spade terminal marked **W**.
8. Carefully reposition the electronics enclosure on the flow sensor body, so that the screw holes in the enclosure are aligned with those in the body.
9. Fasten and tighten the four (4) retained securing screws.
10. Reinstall the flow switch in the flow circuit. Replace the Teflon tape or other thread lubricant at all plumbing connections.
11. Reconnect the flow switch to the power supply.

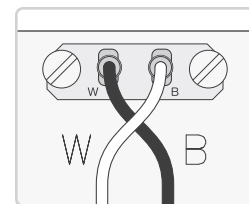
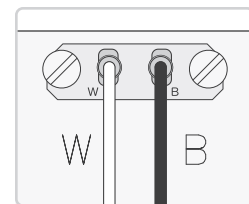

Reversed connections for 1.9–9.5 LPM / 0.5–2.5 GPM flow range.

4 INSTALLATION AND SETUP

Minimum Pipe/Connection Inside Diameter

The flow response of a 100 Series flow switch, and thus its accuracy, may be affected by the inside diameters of the incoming pipe as well as any connecting device attached to the inlet connection and any nearby upstream devices.

NOTE	
	The inside diameter (ID) of the inlet pipe or through-hole of a tube connector, hose barb, or other connecting element must be greater than or equal to the ID of the flow switch.

The table below lists the minimum pipe/connection IDs necessary for standard 100 Series products. If the ID of your pipe or fitting is less than the orifice ID of your flow switch, the flow response values may not be correct. Accurate flow response characteristics can be developed to allow 100 Series products to be used with connecting elements with IDs smaller than those shown. For more information, please contact Proteus Technical Support.

BASE MODEL NUMBER	PORTS		MINIMUM I.D. OF INLET PIPE OR CONNECTION							
	IN	OUT	CELCON		POLYPROPYLENE		BRASS		STAINLESS STEEL	
0100xxx – 101*	A	B	3.175 mm	0.125 in	3.175 mm	0.125 in	3.175 mm	0.125 in	3.175 mm	0.125 in
– 105*	B	C	5.156 mm	0.203 in	5.156 mm	0.203 in	5.156 mm	0.203 in	5.156 mm	0.203 in
– 103*	D	C	8.890 mm	0.350 in	9.525 mm	0.375 in	9.525 mm	0.375 in	9.525 mm	0.375 in
0104xxx	A	B	2.388 mm	0.094 in	2.388 mm	0.094 in	1.600 mm	0.063 in	2.388 mm	0.094 in
0101xxx	A	B	3.175 mm	0.125 in	3.175 mm	0.125 in	3.175 mm	0.125 in	3.175 mm	0.125 in
0105xxx	D	C	5.334 mm	0.210 in	6.858 mm	0.270 in	6.858 mm	0.270 in	6.858 mm	0.270 in
0103xxx	D	C	8.890 mm	0.350 in	9.525 mm	0.375 in	9.525 mm	0.375 in	9.525 mm	0.375 in
0150xxx	D	C	10.67 mm	0.420 in	11.68 mm	0.460 in	11.68 mm	0.460 in	11.68 mm	0.460 in
0155xxx	D	C	14.27 mm	0.562 in	14.27 mm	0.562 in	14.27 mm	0.562 in	14.27 mm	0.562 in
0160xxx	D	C	N/A		19.05 mm	0.750 in	19.05 mm	0.750 in	17.14 mm	0.675 in
0170xxx	D	C	N/A		25.40 mm	1.000 in	25.40 mm	1.000 in	25.40 mm	1.000 in

*The number following the dash represents a selectable flow range model configuration. Refer to page 7 for more information.

Proximity to Other Devices

The flow response of a 100 Series flow switch, and thus its accuracy, may be affected by the form of any devices attached to the inlet connection as well as any nearby upstream devices. Elbows, T-pieces, valves, or filters located immediately upstream from the flow switch can introduce a swirling motion to the liquid flow, reducing the linear velocity of the flow stream.

NOTE	
	To minimize the effects of upstream devices and ensure optimal performance, a run of straight pipe with a length of at least 10 times the pipe ID should be present between the flow switch and any upstream devices. Refer to the table above for the minimum pipe ID for your model. 100 Series products are typically unaffected by the form or proximity of downstream devices.

Appropriate calibration procedures must be applied to ensure accurate trip point settings if elbows or T-pieces are to be attached directly to the inlet connection. For more information, please contact Proteus Applications Support.

4 INSTALLATION AND SETUP

Filtering

Your circulating liquid may contain particles. While not essential to the operation of the flow sensor, it is good practice to filter your liquid. A 100-micron filter is often used to remove rust and other particles from the liquid. This can increase the useful lifetime of pumps and other liquid system components, as well as reduce wear in the sensor.

Plumbing Connections

1. Identify the connection size for your 100 Series flow switch from the table on page 4 and the orifice size from the table on page 8.

NOTE	
	It is recommended that connections to brass or stainless steel flow sensors be made with similar materials to minimize potential corrosion damage.

CAUTION!	
	DO NOT install metal fittings into units with Celcon or polypropylene bodies. The over-tightening of metal fittings in plastic bodies can permanently damage the NPT threads and prevent the creation of a leak-free connection.

2. Make connections to pipe or other fittings as required.

» NPT Pipe Thread Connections

Pipe threads seal by making metal-to-metal or plastic-to-plastic contact between male and female components. Consequently, they are particularly prone to the damaging effects of galling, which occurs when two surfaces move against each other under pressure.

For this reason, it is essential to use a high-quality lubricating and sealing material when installing pipe threads. It is recommended that you use a non-hardening pipe sealant, such as Teflon® (PTFE) tape or paste, on pipe threads to create leak-tight and lubricated junctions at all connection points.

CAUTION!	
	DO NOT use anaerobic pipe sealants such as Loctite® or Swak® brand sealants with 100 Series products fitted with polysulfone faceplates. The aggressive chemical nature of solvent vapors arising from these materials can cause cracks to develop in the faceplate material.

» SAE Straight Thread Connections

With SAE connections, an O-ring makes the seal while the threads hold the connecting assembly in place. Straight thread connections should receive a small amount of high-pressure lubricant before installation to prevent galling.

NON-ADJUSTABLE FITTINGS

- i. Using a wrench, bring the non-adjustable fitting into firm contact with the face of the port.
- ii. Check to be certain that the O-ring fits easily into the non-threaded recessed receiving area of the port, and that it is not pinched or damaged.

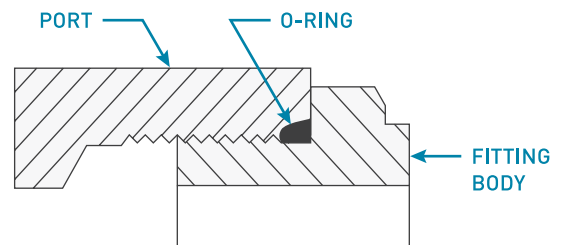

4 INSTALLATION AND SETUP

Plumbing Connections (Continued)

» SAE Straight Thread Connections (Continued)

ADJUSTABLE FITTINGS

- i. Ensure that the locknut is positioned so that the backup washer is in contact with the beginning of the threads farthest from the end of the fitting.
- ii. Screw the fitting into the port until the backup washer makes contact with the sealing face.
- iii. Check to be certain that the O-ring fits easily into the non-threaded recessed receiving area of the port, and that it is not pinched or damaged.
- iv. Unscrew the fitting no more than one turn to position it in the desired direction.
- v. Tighten the locknut firmly against the backup washer so that the fitting assembly is held securely in place.

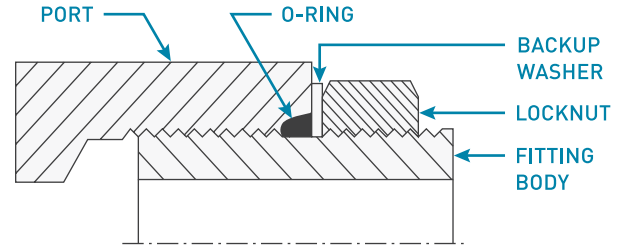

3. Slowly turn the liquid flow ON.
4. Check for leaks at all connection points.
5. Tighten connections as required to eliminate leaks.
6. Eliminate entrained air from the flow cavity.

NOTE



Air bubbles entrained between the rotor spokes reduce resistance to the rotation of the rotor and allow the rotor to spin faster. As a result, the sensor will register a higher-than-actual flow rate until all air bubbles have been eliminated from the flow cavity.

The air bubbles may disperse out of the flow cavity over several hours of operation. The rate of dispersion is speeded by mounting the device with the flow path uppermost. Pulsing the liquid flow by rapidly increasing and decreasing the flow rate through the system can also assist by accelerating the bubbles toward the outlet port.

Electrical Connections

CAUTION!



The installation of this product should only be performed by personnel familiar with the electrical circuitry and control functions of the system in which it is to be installed.

» 24 VDC Version

Standard 24 VDC versions of the 100 Series flow switch are fitted with a five-core cable for connection to the user's control system.

1. Locate the 24 VDC power source and turn it OFF.
2. Make all wire connections following the wiring diagram to the right.
3. Check all connections to ensure that they are secure.
4. Turn the 24 VDC power source ON.

COLOR	FUNCTION
Brown	+24 VDC (Power Supply +)
White	0 VDC (Power Supply -)
Red	Relay N.O. Contact
Green	Relay N.C. Contact
Black	Relay Common

4 INSTALLATION AND SETUP

Electrical Connections (Continued)

» 120 VAC Version

Standard 120 VAC versions are fitted with a two-core power cord with polarized plug and a three-core cable for connection to the user's control system.

1. Locate the power source and turn it OFF.
2. Make all wire connections following the wiring diagram to the right.
3. Check all connections to ensure that they are secure.
4. Insert the power cord plug into a 120 VAC polarized receptacle.
5. Turn the 120 VAC power source ON.

COLOR	FUNCTION
Red	Relay N.O. Contact
Green	Relay N.C. Contact
Black	Relay Common

Trip Point Adjustment

The trip point of a 100 Series flow switch is user-adjustable by means of a 20-turn potentiometer accessible from the back of the electronics enclosure.

The trip point should be at least 10% below the normal operating flow rate. This nominal flow rate should be around 50–60% of the upper flow limit of the sensor to ensure optimal performance.

When selecting a flow switch, ensure that your nominal flow rate is not in the bottom 20% of the sensor's flow range, as this will force you to set a trip point that is close to both your nominal flow rate and the bottom of the sensor's range.

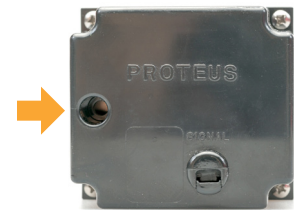

NOTE



An optional factory trip point setting is available for standard and customized 100 Series products (excluding 0100xxxx models with an adjustable flow range).

The factory trip point will be preset to be accurate for water with a falling flow, unless otherwise specified. For more information, please contact Proteus Applications Support.

1. Install the flow switch in your actual flow circuit or on your calibration bench.

NOTE



If you are using a separate calibration bench to adjust the trip point, make sure that you use the same style of inlet fitting as will be used in your actual installation.

2. Turn the liquid flow ON and adjust the actual flow to the minimum acceptable flow rate. Ensure that the flow rate is steady and that all air has been purged from the flow circuit.
3. Connect an ohmmeter or continuity meter between the appropriate wires on the output cable.
 - » For normally open (N.O.) operation, use the **black** and **red** wires.
 - » For normally closed (N.C.) operation, use the **black** and **green** wires.
4. Remove the replaceable protective label that covers the recess in the electronics enclosure.

4 INSTALLATION AND SETUP

Trip Point Adjustment (Continued)

5. Using a small slotted screwdriver, adjust the potentiometer until the meter indicates that the relay has tripped.
 - » Turning the potentiometer **counterclockwise** will **raise** the trip point.
 - » Turning the potentiometer **clockwise** will **lower** the trip point.

There is a small time delay between when the trip point is crossed and when the relay trips. The adjustment should be made slowly to avoid overshooting.

- » With normally open (N.O.) connections, the contacts will open, indicated by the measured resistance changing from zero ohms to infinite resistance.
- » With normally closed (N.C.) connections, the contacts will close, indicated by the measured resistance changing from infinite resistance to zero ohms.

NOTE	
	<p>The actual trip point flow is different for rising and falling flows.</p> <p>For applications in which an exact setting is required, be sure to test the trip point by reducing flow through the trip point or increasing flow through the trip point as required by your particular application.</p>



6. Replace the protective label over the recess in the electronics enclosure.

5 MAINTENANCE

Recommended Maintenance

NOTE	
	Periodic maintenance of your flow switch is recommended to ensure reliable operation.

Maintenance of 100 Series products is normally limited to cleaning the chamber in which the rotor spins. The frequency of cleaning will vary with the type of fluid being run through the device and the cleanliness of the fluid. In most cases, annual cleaning is sufficient.

NOTE	
	The presence of contaminants or particulates in the fluid used with a 100 Series flow switch can greatly accelerate the wear to components inside the flow cavity and may necessitate the replacement of these perishable items.

The flow response of your flow switch will change as the rotor and its bearing shaft wear. Replacing these components will enhance the flow response of the device.

Rebuild Kits

100 Series rebuild kits containing replacements for all perishable components are available from Proteus Industries and our service partners around the world. For more information, please contact Proteus Sales at sales@proteusind.com or (650) 964-4163.

Required Tools

- » Wrenches to disconnect the device from your flow circuit
- » A slotted screwdriver to remove the screws securing the faceplate to the flow sensor body
- » A soft cleaning cloth dampened with water, alcohol or a light detergent solution to clean the flow sensor components

Flow Sensor Maintenance Instructions

1. Turn liquid flow OFF and remove the device from your flow circuit.
2. Place the unit on a clean, flat surface.

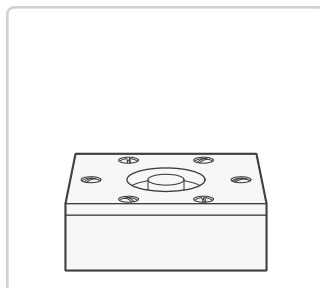

3. Remove and retain the six (6) screws securing the faceplate to the flow sensor body.

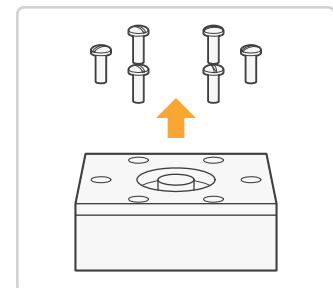

5 MAINTENANCE

Flow Sensor Maintenance Instructions (Continued)

4. Separate the faceplate assembly from the body.

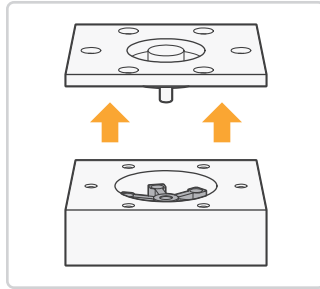

5. Separate the O-ring from the faceplate assembly and inspect it.

If it is brittle, cracked or otherwise worn, replace the O-ring.

Otherwise, clean with a damp cloth.

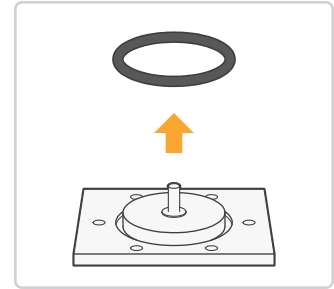

6. Inspect the stainless steel shaft on the faceplate assembly.

If the shaft shows signs of scoring or other wear, replace the faceplate.

Otherwise, clean with a damp cloth.

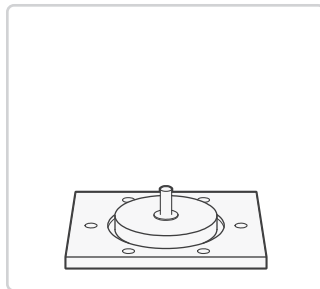

7. Remove the rotor from the flow sensor cavity and inspect it.

If the bearing surface is worn or no longer round, replace the rotor.

Otherwise, clean with a damp cloth.

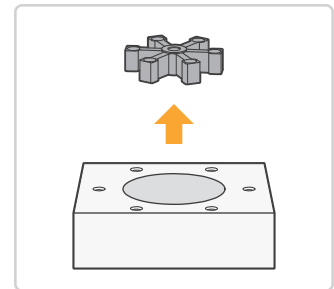

8. Clean the inside of the flow sensor cavity with a damp cloth.

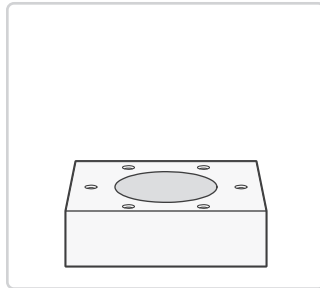

9. Place the rotor in the flow sensor cavity.

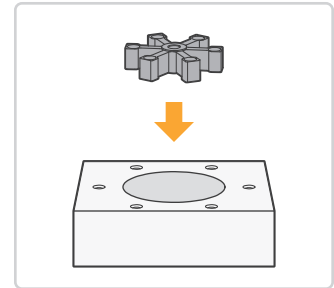

10. Position the O-ring inside the groove on the inner surface of the faceplate.

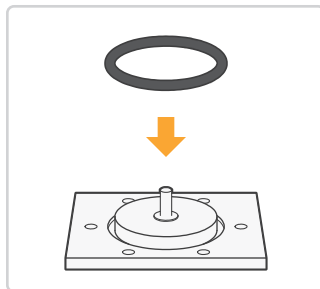

11. Carefully align the faceplate assembly with the flow sensor cavity so that the shaft will pass through the hole in the center of the rotor.

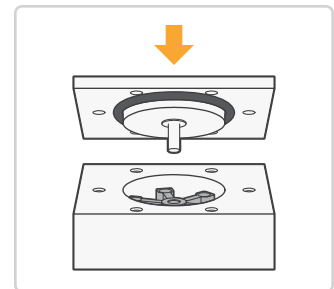

5 MAINTENANCE

Flow Sensor Maintenance Instructions (Continued)

12. Confirm that the faceplate assembly is fitted correctly to the flow sensor body and that the holes in the faceplate are aligned with those in the body.

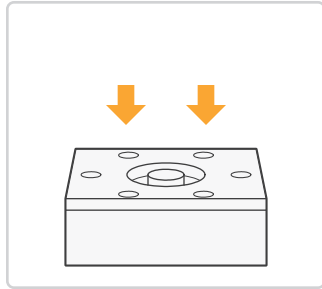

13. Fasten and tighten the six (6) retained securing screws.

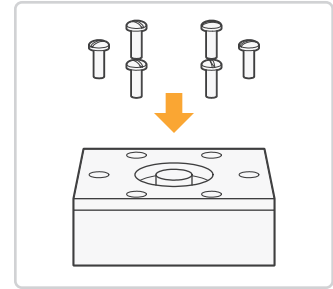

14. Reinstall the flow switch in your flow circuit. Replace the Teflon tape or other thread lubricant at all plumbing connections.
15. Turn liquid flow ON and check for leaks at the faceplate and all connecting ports.
16. Tighten all connections as required to eliminate leaks
17. Eliminate entrained air from the flow sensor cavity. (Refer to the NOTE statement on page 10 for more information.)